

# SERVICE & OPERATING MANUAL AIR OPERATED DOUBLE DIAPHRAGM PUMP

## **B06** **AIR OPERATED** **DOUBLE DIAPHRAGM PUMP**

**Non-Metallic**  
**04 Series**



### Table of Contents

Service / Maintenance Log.....	2
Performance Curve .....	3
Dimensions.....	3
Engineering Data & Temperature limitations.....	4
Explanation of Pump Nomenclature.....	4
Principle of Pump Operation.....	5
Installation guide.....	5
Troubleshooting .....	6
Recycling.....	6
Important Safety Information.....	6
Warranty.....	7
Service.....	7
Air Valve Overhaul.....	7
Wet-side Overhaul.....	7
Parts List .....	8
Assembly Drawing.....	9
Declaration Of Conformity .....	10



## Service / Maintenance Log

Date	Details	Completed

### Contact Information

Contact	Phone / Fax No.

# GA Drawing & Performance Curve

General Assembly :- B06 Non-Metallic pump  
 All dimensions +/- 1mm

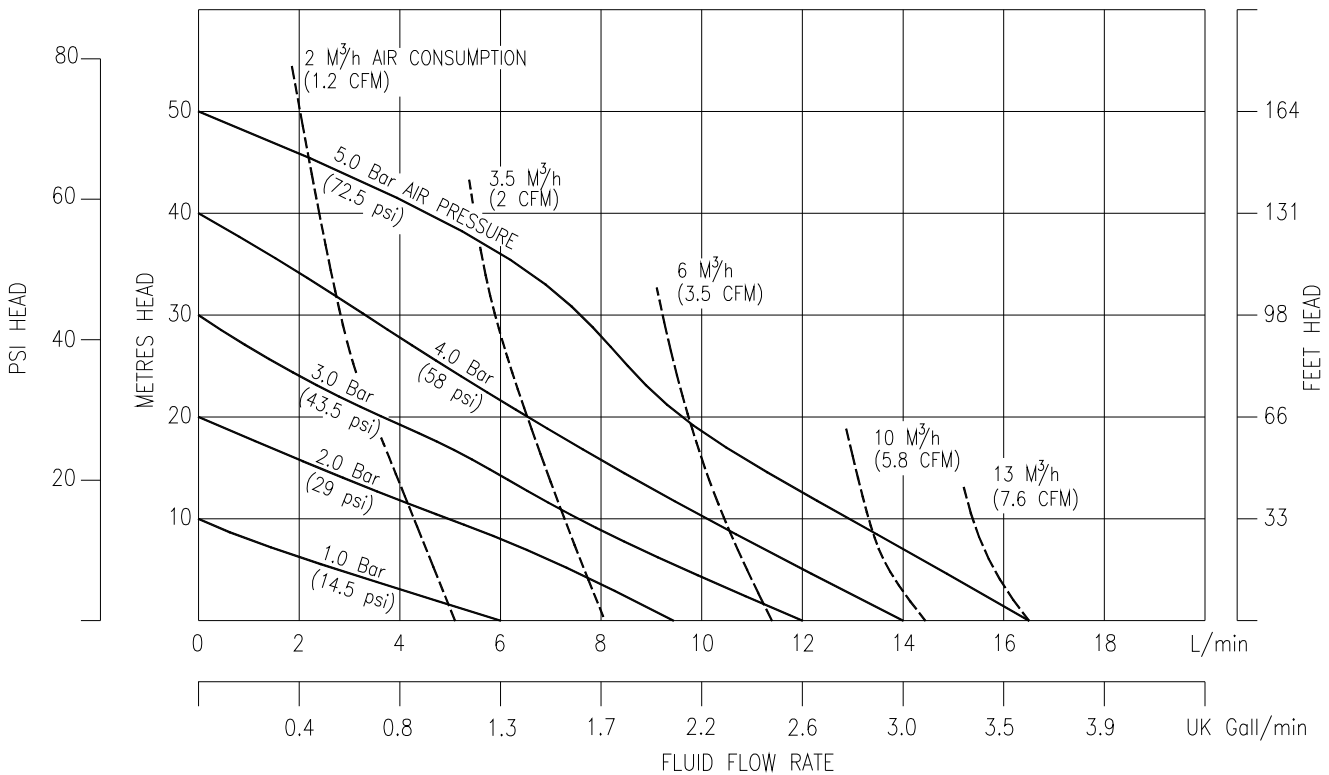
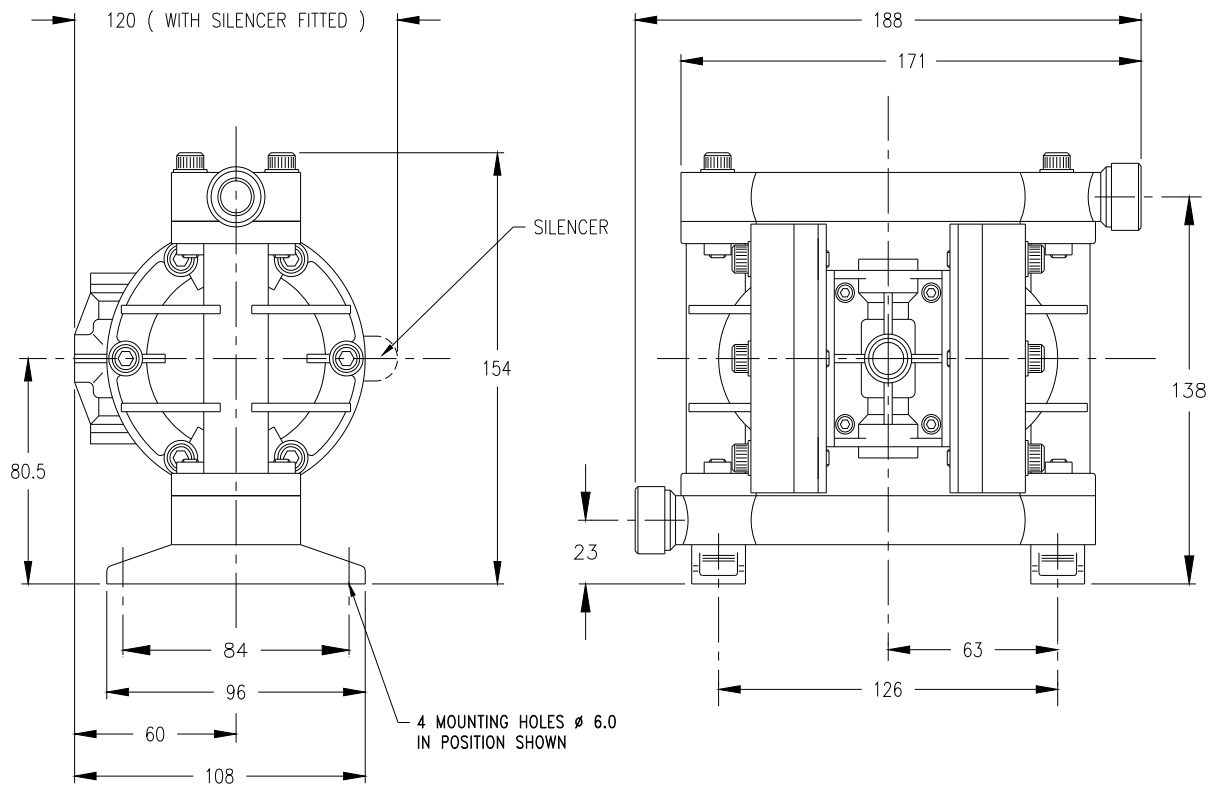

B06 Non-Metallic Pump Performance Curve, performance based on water at ambient temperature.

## TECHNICAL DATA

<b>FLUID CONNECTIONS</b> 1/4" BSP (T)	<b>CAPACITY</b> 0 - 16 Litres/Minute (0 - 3.5 Gallons/Minute)	<b>MAX SOLIDS</b> 1 MM (1/16")	<b>MAX DISCHARGE HEAD</b> 51 Meters (167 ft)	<b>DISPLACEMENT/STROKE</b> 0.015 Litres (0.003 UK Gallons)
<b>MAX. WORKING PRESSURE</b> 5.0 Bar (72.5 psi)	<b>AIR INLET</b> 1/4" BSP (F)	<b>TEMPERATURE LIMITS</b> Determined by Elastomers		<b>PUMP WEIGHTS :-</b> PP :- 1.2 Kg KP :- 1.4 Kg

**ⓘ Caution - Operating temperature limitations are as follows:**

Materials	Operating Temperatures		
	Maximum	Minimum	Optimum
<b>Buna-n</b> - General purpose, oil resistant. Shows good solvent, oil, water and hydraulic fluid resistance. Should not be used with highly polar solvents like acetone and MEK, ozone, chlorinated hydrocarbons and nitro hydrocarbons.	176°F 80°C	-18°F -28°C	50° to 140°F 10° to 60°C
<b>EPDM</b> - Shows very good water and chemical resistance. Has poor resistance to oils and solvents, but is fair on ketones and alcohols.	212°F 100°C	-11°F -24°C	50° to 212°F 10° to 100°C
<b>Neoprene</b> - All purpose. Resistant to vegetable oil. Generally not affected by moderate chemicals, fats greases and many oils and solvents. Generally attacked by strong oxidising acids, ketones, esters, nitro hydro carbons and chlorinated aromatic hydrocarbons.	212°F 100°C	-4°F -20°C	50° to 130°F 10° to 54°C
<b>Santoprene®</b> - Injection moulded thermoplastic elastomer with no fabric layer. Long mechanical flex life. Excellent abrasion resistance.	212°F 100°C	-10°F -23°C	50° to 212°F 10° to 100°C
<b>Virgin PTFE</b> - Chemically inert, virtually impervious. Very few chemicals are known to react chemically with PTFE : molten alkali metals, turbulent liquid or gaseous fluorine and a few fluoro-chemicals such as chlorine trifluoride or oxygen difluoride which readily liberate free fluorine at elevated temperatures.	356°F 180°C	32°F 0°C	50° to 212°F 10° to 100°C
<b>Viton®</b> - Shows good resistance to a wide range of oils and solvents : especially all aliphatic, aromatic and halogenated hydrocarbons, acids, animal and vegetable oils.	356°F 180°C	0°F -18°C	75° to 212°F 24° to 100°C
<b>Polypropylene</b> - High strength, light weight, corrosion resistant polyolefin which easily withstands most chemicals, with no known solvent at room temperature.	158°F 70°C	32°F 0°C	50° to 140°F 10° to 60°C

**TYPICAL CODE = B06.04.P P. B B. E T P**

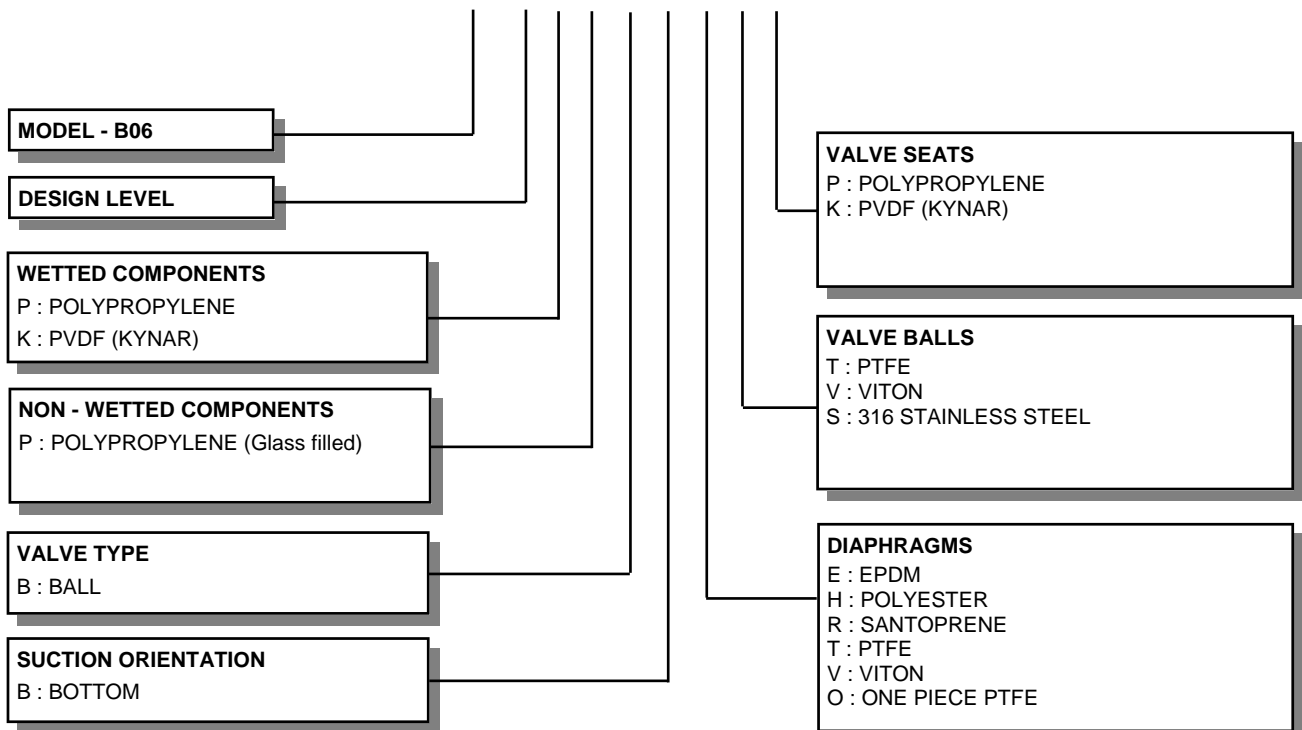

**IMPORTANT**

This pump should be used in accordance with the requirements of the Safety, Health & Welfare at Work Act 2005.  
All business conducted subject to IDEX Pump Technologies, Ireland. Terms and Conditions of Sale, available on request.



IDEX Pump Technologies (Ireland) Ltd.,  
A Unit of IDEX Corporation,  
R79, Shannon, Co Clare, IRELAND.  
TEL. : +353 61 471933 FAX. : +353 61 475046  
Web Site : [www.blagdonpump.com](http://www.blagdonpump.com)  
E-Mail : [sales@blagdonpump.com](mailto:sales@blagdonpump.com)

# PRINCIPLE OF PUMP OPERATION

This ball valve type diaphragm pump is powered by compressed air and is a 1:1 ratio design. The inner side of one diaphragm chamber is alternately pressurised while simultaneously exhausting the other inner chamber. This causes the diaphragms, which are connected by a common shaft secured by plates to the centres of the diaphragms, to move in a reciprocating action. (As one diaphragm performs a discharge stroke the other diaphragm is pulled to perform the suction stroke in the opposite chamber.) Air pressure is applied over the entire inner surface of the diaphragm while liquid is discharged from the opposite side of the diaphragm. The diaphragm operates in a balanced condition during the discharge stroke which allows the pump to be operated at discharge heads of over 200 feet (61 meters) of water.

For maximum diaphragm life, keep the pump as close to the liquid being pumped as possible. Positive suction head in excess of 10 feet of liquid (3.048 meters) may require a back pressure regulating device to maximize diaphragm life.

Alternate pressurising and exhausting of the diaphragm chamber is performed by an externally mounted, pilot operated, 2 way distribution valve. When the spool shifts to one end of the valve block body, inlet pressure is applied to one chamber and the other diaphragm chamber exhausts. When the spool shifts to the opposite end of the valve body, the pressure to

the chambers is reversed. This alternating movement of the spool inside the valve body is controlled by a pilot air pressure signal held against the diaphragm shaft, between seals in the diaphragm shaft bushes. This signal is released, triggering the movement of the spool, when pilot holes in the diaphragm shaft align with the held pilot signal, sending the signal to exhaust, which in-turn causes a pressure imbalance around the spool, sending it to the opposite end of the valve body. This simultaneously sends inlet pressure to the opposite chamber.

The chambers are connected by manifolds with a suction and discharge ball valve for each chamber, maintaining flow in one direction through the pump.

## INSTALLATION

The typical installation shown in FIG. 1 is only a guide to selecting and installing system components. Your installation will depend on the type of fluid being pumped and your application needs. To reduce the risk of serious bodily injury and damage to property, never use fluids in this pump which are not compatible with the wetted components. Contact your local distributor or the manufacturer for system design assistance & compatibility if necessary.

Mount the pump in an upright position. Failure to ensure an upright position may result in loss of or poor priming characteristics. Ensure the pump is securely mounted to avoid movement and possible risk of bodily injury.

**PRESSURE** The pump delivers the same

pressure at the discharge outlet as the air pressure applied at the air inlet (unless pump is configured as a 2:1 ratio model).

**NOTE:** *Pressure Regulator (H) should be installed where air supply could exceed 125 psi.*

## **SAFETY**

Your **BLAGDON PUMP** is a high performance unit capable of achieving high outputs at high efficiencies. However, as is common with pneumatic equipment, the pump efficiencies is reliant upon the air being clean, dry and filtered. Failure to comply with these requirements may lead to loss of performance and reduced component life and in extreme cases, permanent damage to the pump.

To avoid leaks, ensure that all fluid connections are tight. The use of PTFE thread tape correctly applied should be used to ensure 100% leak proof connections. **Failure to ensure 100% sealability of the suction connection could adversely affect suction performance.**

If you are pumping hazardous fluids, or operating the pump in an enclosed area, it is essential that the exhaust from the pump is piped away to a safe location. When pumping hazardous fluids the above instructions must be adhered to in order to ensure safe operating procedures. (Under certain operating conditions the failure of internal components can lead to the pumped fluid being exhausted via the pump exhaust outlet).

## **WARNING**

**NEVER place your hands over or near the pump suction inlet. Powerful suction could cause serious bodily injury.**

**FLUSH THE PUMP** This pump was tested with water containing an oil-based rust inhibitor. If this solution could contaminate or react with the fluid you are pumping, flush the pump thoroughly with a solvent/detergent to clean internal components. The solvent/detergent must be compatible with the pump materials of construction. Care should be taken to flush the pump each time it is disassembled for maintenance or repair.

**CAUTION** All **BLAGDON PUMPS** are built lubricated with a light oil during assembly and need no further lubrication. If the use of oil cannot be avoided, this will not present any problems. A light SAE10 lubricating oil is recommended. Other grades may cause the Air Logic System to operate intermittently, thereby causing a loss of output and failure to operate. Other seals are available for "clean room" conditions.

If the pump accelerates or is running too fast due to a lack of fluid, then stop it immediately by shutting off the air supply. A dry pump will accelerate to a high speed causing wear to elastomers.

If the fluid you are pumping tends to dry up or set when it is not moving, then flush the pump as often as necessary to prevent the fluid from drying in the pump. Drain the pump thoroughly before storing.

If feasible, invert pump to allow any fluid to drain from the non-return valves.

Available from  
Blagdon Pump

- ① Pulsation Dampener
- ② Lubricator
- ③ Filter/Regulator
- ④ Air Dryer

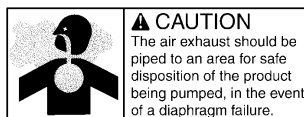

Installation Guide  
Fig. 1

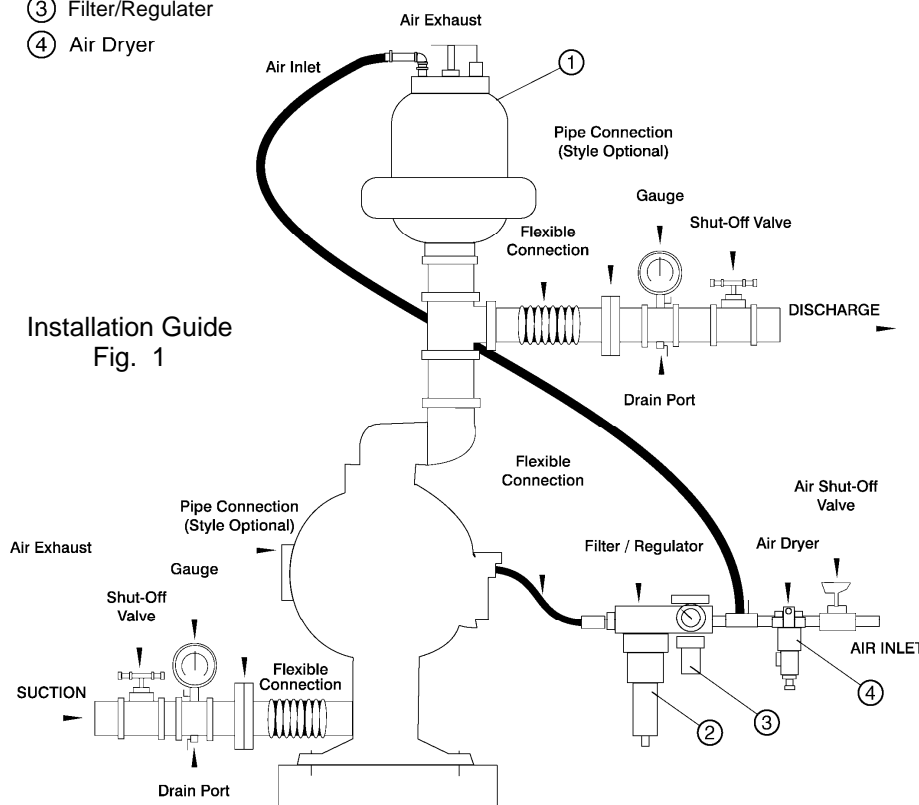

# TROUBLE SHOOTING GUIDE

**NOTE :- Check all solutions before dismantling the pump.**

PROBLEM	CAUSE	SOLUTION
Pump will not start	Air valve assembly malfunction/Seizure  Obstructed fluid line. Obstructed diaphragm chamber. Diaphragm failure causing fluid & excessive air to be expelled through the exhaust. Diaphragm seal failure. Air valve system malfunction. Air connected to exhaust.	Check carrier for freedom of movement. - Clean, oil & replace. Clean line or increase line size. Remove obstruction. Replace diaphragm.  Replace shaft seals. Check all seals in valve chest assembly. Re-connect to air inlet.
Erratic flow	Diaphragm failure on one side. Valve ball not seating. Suction leakage. Diaphragm failure causing fluid & excessive air to be expelled through the exhaust. Diaphragm seal failure. Air valve system malfunction.	Replace diaphragm. Check and remove obstruction. Check and correct. Replace diaphragm.  Replace shaft seals. Check all seals in valve chest assembly.
Pump strokes but will not discharge	Excessive suction lift. Suction line leakage. Valve ball not seating correctly or damaged. Suction line or strainer clogged. Diaphragm failure.	Shorten suction line. Check and correct. Check and remove obstruction / replace. Clear. Replace diaphragm.
Fluid discharged from air exhaust	Diaphragm Failure. Loose frontplate.	Replace diaphragm. Re-Torque to manual specifications.
Intermittent stroke rate	Over lubrication  Diaphragm shaft seal failure. Air valve system malfunction. Valve ball not seating / partially obstructed.	Shut-down pump. Remove air connection into pump & introduce a small quantity of degreasing agent into air valve and replace line. Run pump until clear. Replace seals. Check all seals in valve chest assembly. Clear obstruction.



## WARNING!

Read these safety warnings and instructions in this manual completely, before installation and start-up of the pump. It is the responsibility of the purchaser to retain this manual for reference. Failure to comply with the recommendations stated in this manual will damage the pump, and void factory warranty.



## WARNING!

Before maintenance or repair, shut off the compressed air line, bleed the pressure, and disconnect the air line from the pump. The discharge line may be pressurized and must be bled of its pressure.



## WARNING!

In the event of diaphragm rupture, pumped material may enter the air end of the pump, and be discharged into the atmosphere. If pumping a product which is hazardous or toxic, the air exhaust must be piped to an appropriate area for safe disposition.



## WARNING!

Before doing any maintenance on the pump, be certain all pressure is completely vented from the pump, suction, discharge, piping, and all other openings and connections. Be certain the air supply is locked out or made non-operational, so that it cannot be started while work is being done on the pump. Be certain that approved eye protection and protective clothing are worn all times in the vicinity of the pump. Failure to follow these recommendations may result in serious injury or death.



## WARNING!

Take action to prevent static sparking. Fire or explosion can result, especially when handling flammable liquids. The pump, piping, valves, containers or other miscellaneous equipment must be grounded.



## CAUTION!

Before pump operation, inspect all gasketed fasteners for looseness caused by gasket creep. Retorque loose fasteners to prevent leakage. Follow recommended torques stated in this manual.



## IMPORTANT!

This pump is pressurized internally with air pressure during operation. Always make certain that all bolting is in good condition and that all of the correct bolting is reinstalled during assembly.



## RECYCLING

Many components of BLAGDON air operated double diaphragm pumps are made of recyclable materials. We encourage pump users to recycle worn out parts and pumps whenever possible, after any hazardous pumped fluids are thoroughly flushed.



## WARNING!

Airborne particles and loud noise hazards. Wear ear and eye protection.



## WARNING!

When used for toxic or aggressive fluids, the pump should always be flushed clean prior to disassembly.



## IMPORTANT!

Read these instructions completely, before installation and start-up. It is the responsibility of the purchaser to retain this manual for reference. Failure to comply with the recommendations stated in this manual will damage the pump, and void factory warranty.

## SERVICE

The following sections give a general overview on how to service all models of BLAGDON Diaphragm Pumps. For details on individual part numbers, quantities, materials, etc., please consult the parts list supplied with the pump.

**NOTE :** *Before commencing any service or maintenance work on the pump, ensure that the air supply has been disconnected or isolated.*

### AIR VALVE SYSTEMS

**PNEUMATIC TYPE** Remove the 4 screws securing the valve block to the valve chest, together with any associated gaskets or seals.

Remove slide valve plate & slide valve from the valve block assembly. Clean all parts thoroughly and inspect for excessive wear, replacing where necessary.

The slide valve and valve plate contact faces should be flat and free from scratches. A light polishing on a flat surface with a fine abrasive paper will remove most scratches.

If excessive wear is suspected in the valve block bore or valve carrier, remove the valve block plugs and withdraw the valve carrier. Check valve block plug o-rings for wear or attack & replace where required.

Clean the valve carrier & valve block bore with white spirits to remove any oil films.

**NOTE :** *The nominal diametrical clearance between the valve carrier and the valve block bore should be 0.05 - 0.09mm. A clearance in excess of this will cause the valve system to run erratically.*

Apply a light grease to the valve block plug O-rings when re-assembling into the valve block bore. Any damage to the O-ring may cause the valve system to malfunction.

Re-assemble the valve block assembly &

re-torque in accordance to the settings shown in the parts list.

In the event of a complete air-side overhaul, the pump should be disassembled down to the centre section assembly as described later in the "Wet-Side Overhaul" section.

With the valve block assembly dismantled, remove the inner covers where appropriate.

A careful note of the position of all related seals and gaskets should be made to facilitate re-assembly.

Remove diaphragm shaft bushes, where appropriate, and check all seals and 'O' rings for wear or damage. If worn, replace immediately.

**NOTE:-** *The integrity of the diaphragm shaft seals is essential for the correct functioning of all pneumatically actuated valve systems.*

Check the diaphragm shaft for excessive wear as this will result in premature seal failure. Replace as required. Lubricate all components and re-assemble as detailed above, in reverse order. Ensure the correct position of all components detailed in all sectional assembly drawings.

### WET-SIDE OVERHAUL

#### **REPLACING BALL VALVES**

Remove discharge manifold from pump assembly together with associated valve balls, seats and 'O' rings.

**NOTE :-** *The orientation of the valve seat relative to the valve ball should be noted as incorrect positioning may result in a performance loss.*

Turn pump through 180° and remove the suction manifold. Clean and inspect the components. Check for any wear or damage and replace as required.

**NOTE :-** *Ball or valve seat wear may result in loss of performance and suction lift.*

Re-assemble the valve balls/seats and ensure manifolds are adequately torqued to the settings shown in the parts list.

#### **REPLACING DIAPHRAGMS**

Remove both suction and discharge manifolds as detailed in the previous section, removing all ball valves, seats and 'O' rings.

Loosen and remove both outer covers from the pump assembly. The orientation of the covers should be noted so as to facilitate re-assembly.

Holding one of the frontplates in a vice, ('soft jaws' should be fitted), or with an adjustable spanner, loosen and remove the frontplate from the opposite end. Remove the diaphragm, backplate and bumpstop from diaphragm shaft.

Carefully withdraw the diaphragm shaft from the centre section and hold the free end in a vice, holding between the flats machined on the end. Loosen and remove the frontplate and remove the diaphragm together with backplate and bumpstop (where fitted).

**NOTE :-** *Care should be taken with all plastic, coated and hygienic pumps, so that the surface of the frontplate is not damaged.*

Thoroughly clean all parts and check for wear, damage, swelling, cracking, delamination and chemical attack. Replace components where required.

**NOTE :-** *Rubber diaphragms should be replaced if they are worn to such an extent that the fabric re-enforcing is evident on the surface of the diaphragm.*

For pumps fitted with PTFE diaphragms, a light coating of grease should be applied to the back-up diaphragm prior to re-assembly.

Before re-assembly, it is advisable to check the condition of the diaphragm shaft seal/'O' rings for wear or attack. If either is evident, it is recommended that they be replaced.

Assemble the diaphragms onto the shaft in a reverse sequence to their removal. Care should be taken as to the orientation of the diaphragm relative to the front and back plates. All diaphragms have "AIR SIDE" moulded onto one side. The backplate must be fitted adjacent to the AIR SIDE of the diaphragm.

**PARTS LIST**

REF No.	PART NUMBER	DESCRIPTION	QTY
1	D266	SOCKET CAP SCREW	8
2	C048	WASHER	20
3	SEE TABLE	MANIFOLD	2
4	06-063	MANIFOLD BAND	2
5	SEE TABLE	O-RING	4
6	SEE TABLE	BALL STOP	2
7	SEE TABLE	VALVE BALL (DISCHARGE)	2
8	SEE TABLE	VALVE SEAT (DISCHARGE)	2
9	06-034	SILENCER	1
10	06-170	GASKET	2
11	06-061	INNER COVER RING	2
12	06-036	INNER COVER	2
13	L502	SELF TAPPING SCREW	8
14	SEE TABLE	DIAPHRAGM	2
15	B272	SQUARE NUT	8
16	D355	SOCKET CAP SCREW	12
17	SEE TABLE	VALVE BALL (SUCTION)	2
18	SEE TABLE	VALVE SEAT (SUCTION)	2
19	06-082	VALVE BLOCK STRAP	2
20	06-039	VALVE CHEST	1
21	06-002	PORT SEAL	1
22	06-132	DIAPHRAGM SHAFT	1
23	06-153	DIAPHRAGM SHAFT BUSH 'B' (INNER)	2
24	G279	O-RING	2
25	06-210	DIAPHRAGM SHAFT BUSH 'A' (OUTER)	2
26	06-209	LIP SEAL	6
27	G264	O-RING	2
28	SEE TABLE	OUTER COVER	2
29	SEE TABLE	FRONTPLATE	2
30	06-063	DIAPHRAGM - PTFE OVERLAY	2
31	06-147	DIAPHRAGM SUPPORT	2
32	06-009	BACKPLATE	2
33	D322	SOCKET CAP SCREW	4
34	06-005	VALVE CARRIER	1
35	G258	O-RING	2
36	06-040	VALVE BLOCK PLUG	2
37	D492	SOCKET CAP SCREW	6

**PARTS LIST - cont.**

REF No.	PART NUMBER	DESCRIPTION	QTY
38	06-097	VALVE BLOCK	1
39	06-004	SLIDE VALVE	1
40	06-003	SLIDE VALVE PLATE	1
41	06-059	PLATE SEAL	1
42	SEE TABLE	BASE LEG	2
43	D358	SOCKET CAP SCREW	4
44			

REF No.	DESCRIPTION	POLYPROPYLENE	PVDF	QTY
3	MANIFOLD	06-017	06-128	2
6	BALL STOP	06-099	06-124	2
8	VALVE SEAT (DISCHARGE)	06-171	06-172	2
18	VALVE SEAT (SUCTION)	06-098	06-125	2
28	OUTER COVER	06-100	06-129	2
29	FRONTPLATE	06-037	06-127	2
42	BASE LEG	06-035	06-126	2

ELASTOMER TABLE						
REF No.	DESCRIPTION	HYTREL	EPDM	VITON	PTFE	SANTOPRENE® QTY
14	DIAPHRAGM	06-010	06-070	06-060	06-063 + 06-147	06-147
5	O-RING	G334	G333	G336	G256	-

ELASTOMER TABLE						
REF No.	DESCRIPTION	PTFE	VITON	STAINLESS STEEL	PTFE (ONE-PIECE)	QTY
7	VALVE BALL (DISCHARGE)	06-145	06-151	06-146	-	2
17	VALVE BALL (SUCTION)	06-108	06-109	06-110	-	2
14	DIAPHRAGM	-	-	-	06-174	2

- ◆ - These items are available in a recommended spares kit. Please refer to your local stockist / distributor for details.
- - These items are available in a recommended spares kit - ASK0604 - Air side Kit.

**Note! This kit covers both standard and Lube Free models. There is no "dry air" version available for 06 pumps.**

Santoprene is a registered trade name of Monsanto Corp.



Lip Seal Positions

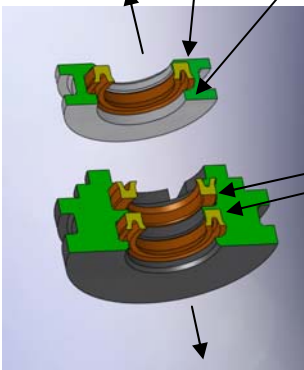

TORQUE SETTINGS	
A	- 1.7 Nm (15 lbs/in)
B	- 1.0 Nm (10 lbs/in)
C	- 1.7 Nm (15 lbs/in)
D	- 2.2 Nm (20 lbs/in)
E	- 1.7 Nm (15 lbs/in)
F	- 4.5 Nm (40 lbs/in)

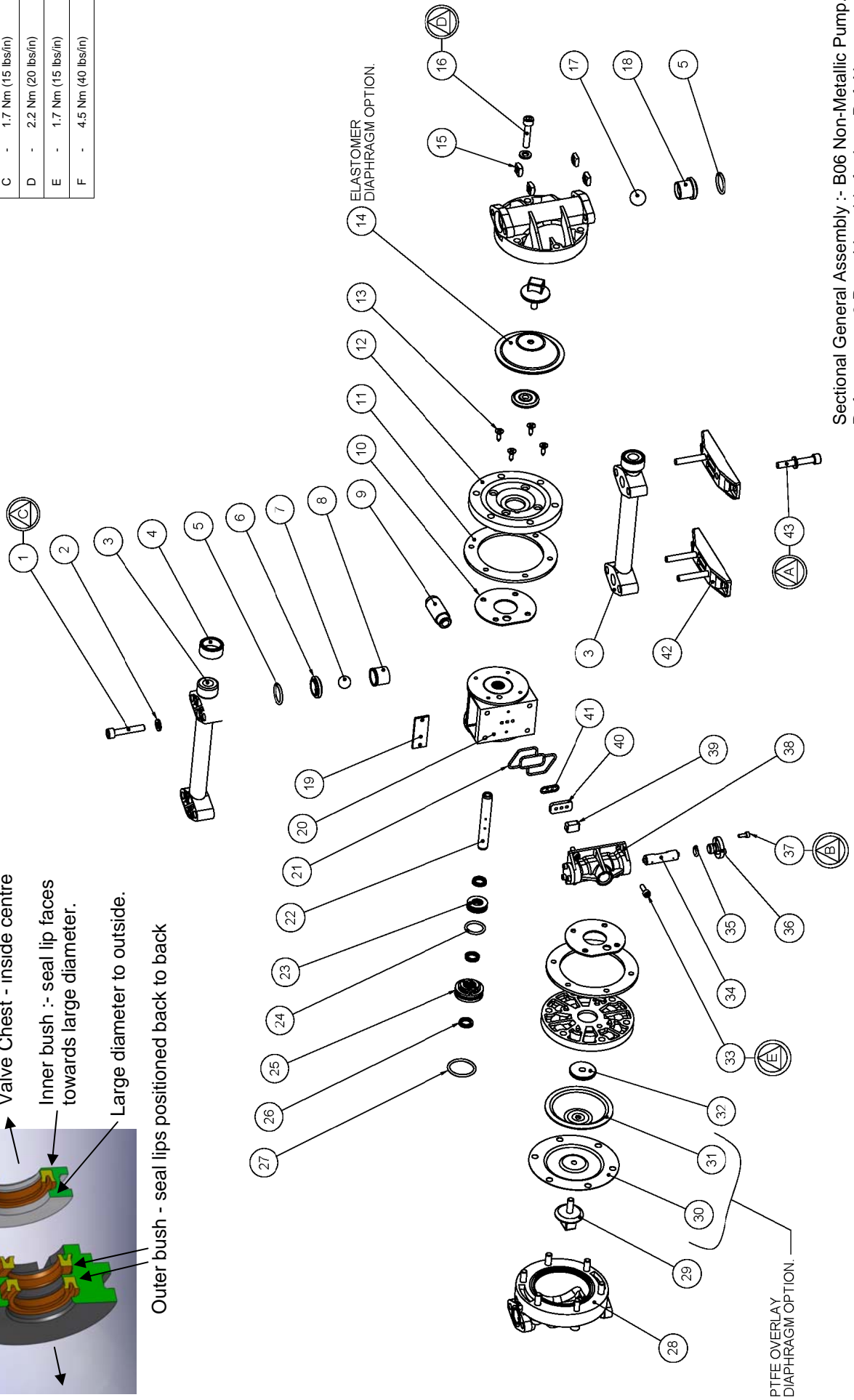

Sectional General Assembly :- B06 Non-Metallic Pump.  
 Refer to page 8 Parts List table for item Ref. Nos.

# Declaration of Conformity

DECLARATION DE CONFORMITE • DECLARACION DE CONFORMIDAD • ERKLÄRUNG BEZÜGLICH EINHALTUNG DER VORSCHRIFTEN •  
DICHIARAZIONE DI CONFORMITÀ • CONFORMITEITSVERKLARING • DEKLARATION OM ÖVERENSSTÄMMELSE •  
EF-OVERENSSTÄMMELSESERKLÄRING • VAATIMUSTENMUKAISUUSVAKUUTUS • SAMSVARSERKLÄRING • DECLARAÇÃO DE CONFORMIDADE •  
Δήλωση Συμμόρφωσης

## MANUFACTURED BY:

FABRIQUE PAR: IDEX Pump Technologies (Ireland) Ltd.,  
FABRICADA POR: A Unit of IDEX Corporation,  
HERGESTELLT VON: R79, Shannon, Co Clare,  
FABBRICATO DA: IRELAND.  
VERVAARDIGD DOOR: TEL. : +353 61 471933  
TILLVERKAD AV: FAX. : +353 61 475046  
FABRIKANT: Web Site : www.blagdonpump.com  
VALMISTAJA: PRODUSENT: E-Mail : sales@blagdonpump.com  
FABRICANTE: Κατασκευαστής:



## PUMP MODEL, TYPE

MODELE, TYPE  
MODELO, TIPO  
MODELL, TYPE:  
MODELLO, TIPO  
MALLI, TYYPI:  
ΜΟΝΤΕΛΟ, ΤΥΠΟΣ:

## SERIAL NO.:

NO. SERIE:  
NO. DE SERIE:  
SERIEN-NR.:  
NUMERI DI SERIE  
SERIENUMMERS:  
TILLVERKNINGS NUMMER:  
SERIENR.:  
SARJA NO.:  
SERIE NR.:  
ΑΡ. ΣΕΙΡΑΣ:

## This product complies with the following European Community Directives:

Ce produit est conforme aux directives de la Communauté européenne suivantes:  
Este producto cumple con las siguientes Directrices de la Comunidad Europea:  
Dieses produkt erfüllt die folgenden Vorschriften der Europäischen Gemeinschaft:  
Questo prodotto è conforme alle seguenti direttive CEE:  
Dit produkt voldoet aan de volgende EG-richtlijnen:  
Denna produkt överensstämmer med följande EU direktiv:  
Blagdon Pump, erklærer herved som fabrikant, at ovennævnte produkt er  
i overensstemmelse med bestemmelserne i Direktive:  
Tämä tuote täyttää seuraavien EC Direktiivien vaatimukset:  
Dette produkt oppfyller kravene til følgende EC Direktiver:  
Este producto está de acuerdo con las siguientes Directivas comunitarias:  
Το παρόν προϊόν πληροί τις εξής οδηγίες της ΕΕ:

**98 / 37 / EC**

## This product has used the following harmonized standards to verify conformance:

Ce matériel est fabriqué selon les normes harmonisées suivantes, afin d'en garantir la conformité:  
Este producto cumple con las siguientes directrices de la comunidad europea:  
Dieses produkt ist nach folgenden harmonisierten standards gefertigt worden, die übereinstimmung wird bestätigt:  
Questo prodotto ha utilizzato i seguenti standards per verificare la conformità:  
De volgende geharmoniseerde normen werden gehanteerd om de conformiteit van dit produkt te garanderen:  
För denna produkt har följande harmoniserande standarder använts för att bekräfta överensstämmelse:  
Harmoniserede standarder, der er benyttet:  
Tässä tuotteessa on sovellettu seuraavia yhdenmukaistettuja standardeja:  
Dette produkt er produsert i overensstemmelse med følgende harmoniserte standarder:  
Este produto utilizou os seguintes padrões harmonizados para verificar conformidade:  
Το παρόν προϊόν χρησιμοποιεί τα ακόλουθα μέτρα και σταθμά εναρμονισμού για την επιβεβαίωση της συμμόρφωσης:

**EN 809**

## AUTHORIZED / APPROVED BY:

Approuve par:  
Aprobado por:  
Genehmigt von:  
approvato da:  
Goedgekeurd door:

Underskrift:  
Vaituutettuna:  
Bemyndiget av:  
Autorizado Por:  
Εγκρίθηκε από:

Des Monaghan,  
Production & Technical Manager

Date : December 01 2009

FECHA:  
DATUM:  
DATA:  
DATO:  
PÄIVÄYS:  
Ημερομηνία:



HG-CF-223 (REV 5)